

tenon
PARTITIONS



fire & sound

A cost effective performer



fire & sound
tenon



fire & sound
at a glance

BOARD
ROOMS

EXECUTIVE
OFFICE SUITES

RECEPTION
AREAS

CONFERENCE
SUITES

GENERAL
OFFICE

CLEAN
ROOM

LIGHT
INDUSTRIAL

Areas of use



Fire performance

- Solid modules - up to 60 minute fire rating.
- Glazed modules - up to 60 minute fire rating in both centre single and double glazed applications.
- Door modules - up to 60 minute fire rating*.

Acoustic performance

- Solid modules - standard construction - up to 52dB (Rw).
- Glazed modules - standard construction - up to 43dB (Rw).
- Door modules - standard solid door core - up to 30dB (Rw).

Construction Options

- Solid modules - standard construction is with 12.5mm plasterboard panels with a wide choice of finishes together with numerous joint and trim options.
- Glazed modules - includes offset single, centre single, double glazing and the option of venetian blinds.
- Door modules - standard frames are supplied to suit 1981 x 838 x 44mm doors. Frames will also accept most types of doors.

Max Construction Heights

- Solid modules - standard construction - up to 4200mm. Heights in excess of this are achievable.
- Glazed modules - maximum recommended height using standard sections - 3600mm.

* 60 minute rating on timber door sets only.

For more information or advice on this system's performance please contact the Tenon Technical Department.



Versatility

Tenon Fire & Sound is a versatile, demountable and re-locatable partition system that provides up to one hour fire performance and high levels of sound reduction.

The variety of partition widths, stud, panel and joint / trim options make the system ideal for a wide range of uses, in both office and light industrial areas.

The system is constructed using an aluminium head channel and galvanised steel studs together with aluminium glazing and door frame sections. The 77mm system is available with centre single, single offset and double glazing. The 102mm system has centre single and double glazing only.

One or two layers of the specified panel can be fitted to provide the level of fire, sound or structural performance required.

Tenon Fire & Sound is well established as one of the most popular performance partition systems available.





All Fire & Sound components are readily available throughout the UK and Ireland, offering a system that gives a high degree of choice in design options, coupled with high performance and aesthetics.

Flexibility

Panel options include plasterboard with bevelled or negative edges to create feature joints, square edge boards for use with the suite of trim sections or tapered edge boards for flush monolithic finish. Panels can be supplied pre-decorated with a choice of wallcoverings or fabricated with laminate or steel facings.

Standard module size is 1200mm. Maximum construction height is determined by the choice of stud size and panel type, however, 102mm Fire & Sound can be built up to a height of 4200mm.

Venetian blinds can be accommodated within the system, as can a range of electrical switches with the use of a cable management post.

Doors are available in natural wood finishes, including Ash, Koto, Oak, Cherry, Beech, Maple and Sapele. All doors can include any shape or size of vision panel or lipping.

For more information or advice on this system's performance please contact the Tenon Technical Department.



Adaptability

77mm Fire & Sound is available with enhanced styling and features:

- » Radius junction posts and door frame profiles
- » Top hat and radius omega trim sections
- » Omega concealed fix skirting
- » Radius single offset and double glazing
- » Switch post and radius end capping section
- » Integrated shelving system

The 102mm system can also be supplied with radius door frame, trim and double glazing sections.

Fire & Sound has been tested to BS476 part 22 and offers up to **60 minutes fire resistance** in full height glazed, solid and door elevations. Insulation performance is available on both solid and glazed elevations. Where acoustic performance is a consideration, the system can provide **sound attenuation values of up to 52dB(Rw)** under laboratory test conditions.

To complement Tenon Fire & Sound, the Nexus range of ironmongery offers a wide choice of door furniture in a variety of finishes.



Construction details are similar for both 77mm and 102mm systems, with the variety of stud, panel and joint / trim options making it suitable for a wide range of locations and uses.

Components

Fire & Sound is constructed from a range of aluminium and galvanised steel sections, that allow the use of a variety of plasterboard and panel types. Details of individual components and their functions can be found in the section guide on page 14 - 15.

Size

Tenon Fire & Sound is based on a standard module width of 1200mm with the two partition thicknesses providing three options of construction:

Overall Width	Stud Size	No of Board Layers
77mm	50mm	One
102mm	50mm	Two
102mm	75mm	One

Maximum construction heights and associated levels of performance are contained within a table on page 15.

Appearance

Aluminium profiles are supplied from stock in a silver anodised finish, Grade AA5, but may be powder coated in a range of twelve standard colours:

RAL 5010 Gentian Blue	RAL 9010 Pure White
RAL 5012 Light Blue	RAL9016 Traffic White
RAL 6005 Moss Green	BS:00 A 05 Light Grey
RAL 7011 Iron Grey	BS:04 E 53 Geranium Red
RAL 9005 Jet Black	BS:08 B 15 Magnolia
RAL 9006 Silver	BS:08 B 29 Van Dyke Brown

Standard BS 4800 and RAL colours not included in the above list are available. However, these may be subject to longer lead times and additional cost.

Plastic glazing and cover trim sections are available in black, white or grey and can be painted to match or contrast office colour schemes.

Plasterboard panels can be faced with paper and fabric backed vinyls or laminates from all leading manufacturers.

Glazing

Glazing is achieved by the use of aluminium sections that are fixed to the steel sub-frame and are available with a choice of plastic glazing beads. The following types of glazing are available within the system:

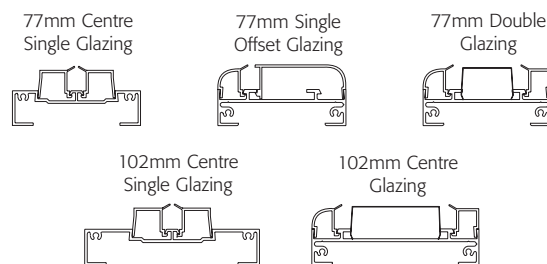

With the use of standard components, glass with a thickness of between 6/7mm may be specified. However, other thicknesses of glass can be accommodated within the system. Fire rating for centre single and double glazing is achieved with the use of a number of additional steel beads and liners. However, only approved glass types may be used. Single offset glazing is available as non-fire rated only

Aluminium glazing profiles have screw-ports that allow frames to be assembled prior to installation. Where accurate site dimensions are available, frames can be supplied pre-cut in pack form complete with glazing beads. Setting out dimensions and glazing apertures can be calculated using the information shown on page 12.

All glass fitted within the system should comply with BS 6262 and Approved Document N of The Building Regulations 1992. Part N1 covers glazed areas of critical locations with regard to safety. This includes all full height partitions, half glazed partitions adjacent to doors and vision panels in doors. Part N2 covers manifestation of glazing in critical locations where people may collide with it.

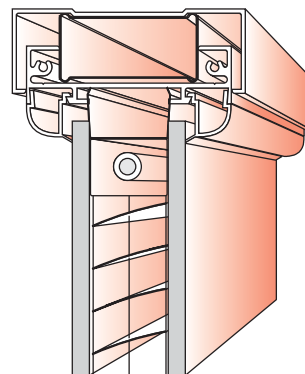

Venetian Blinds

77mm and 102mm Fire & Sound has a minimum internal void of 29mm and will accept both 15mm and 25mm blinds in double glazed and single offset glazed applications.

Solid Panels

Fire & Sound is based around the use of standard 12.5mm plasterboard. However, it can accommodate a wide range of panels and boards that provide varying degrees of decorative choice, fire resistance, sound attenuation, impact and moisture resistance.

Laminated boards and other faced substrates can be fitted within the system and pre-decorated boards are available for fast track installation contracts.

Joint/Trim Options

The system is available with a range of trim and joint options that allow for different methods of construction. The choice of trim/finish will depend on the chosen method and the level of performance required.

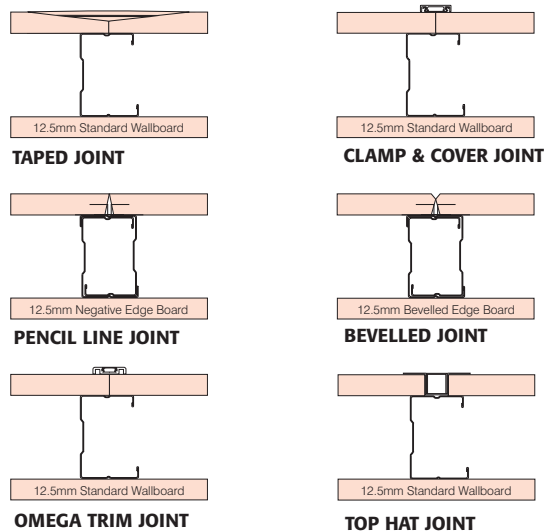

All of the above joint / trim options, except the Top Hat Joint, can be used in 30 minute fire rated partitions.

Door Modules

Standard doorframes are supplied as universal frame packs (i.e. left or right handed), with a choice of frame profile (see below), and come pre-mitred complete with pre-cut steel transom, factory fitted hinges and Tenon lock box and door seal. The door seal has been tested as a smoke seal and complies with the requirements of BS 476 part 31.1.

Fire rated frames do not require a steel liner, but the inclusion of intumescent strip (TF260) within the frame and the use of a suitably rated door closer are necessary to achieve stated performance levels.

When ordering door frames to suit full height doors and doors with over panels, please specify the handing of the door. 60 minute fire rated door assemblies are supplied with hardwood frames.



Doors

Doors are available with veneered or laminate facings with a choice of hardwood or laminate lippings. Both cellular core and solid core doors can be supplied in standard sizes in Sapele, Cherry, Oak, Ash, Koto, Maple and Beech veneers as standard. Non-standard sizes and veneers are available to order. Please contact your nearest Tenon stockist with your requirements.

The full range of Tenon joinery options is available including vision panels, relipping etc. For details of the range of ironmongery available to complement the Tenon range please refer to the latest Tenon Partition price guide.

Fire Performance

Tenon Fire & Sound has been extensively tested and assessed over a number of years and when installed in accordance with company instructions, can provide up to 60 minutes fire resistance to BS 476 part 22, 1987. Test evidence and assessments allow us to offer up to 60 minutes fire rating on:

- SOLID PANELS Continuous runs of 12.5mm plasterboard (square edge, tapered edge, feature joint)
- GLAZING Single and double glazed modules using a suitably rated safety glass. Please check with your local Sales Centre regarding approved materials.
- DOORS Single, double and hospital leaf door sets, full height doors and doors and over panels.

Full details of the capabilities of the system are included in a performance table on page 15.

Acoustic Performance

Tenon Fire & Sound has been thoroughly tested in accordance with BS 2750 part 3, 1980: ISO 140/11 - 1978 and will achieve the following:

- SOLID PANELS Up to 52dB, using suitable board material.
- GLAZING Up to 43dB, in double glazed applications.
- DOORS Up to 30dB when using a suitable threshold seal.

Full details of the acoustic performance of the system are included in a table on page 15.

Product Maintenance

All elements of the Fire & Sound system can be cleaned using a solution of mild detergent in warm water and a soft cloth or sponge. The frequency of cleaning will depend on the environment the partition is situated in and the level to which the surface has been soiled. Full product maintenance details and COSHH data sheets are downloadable from www.tenonpartitions.co.uk

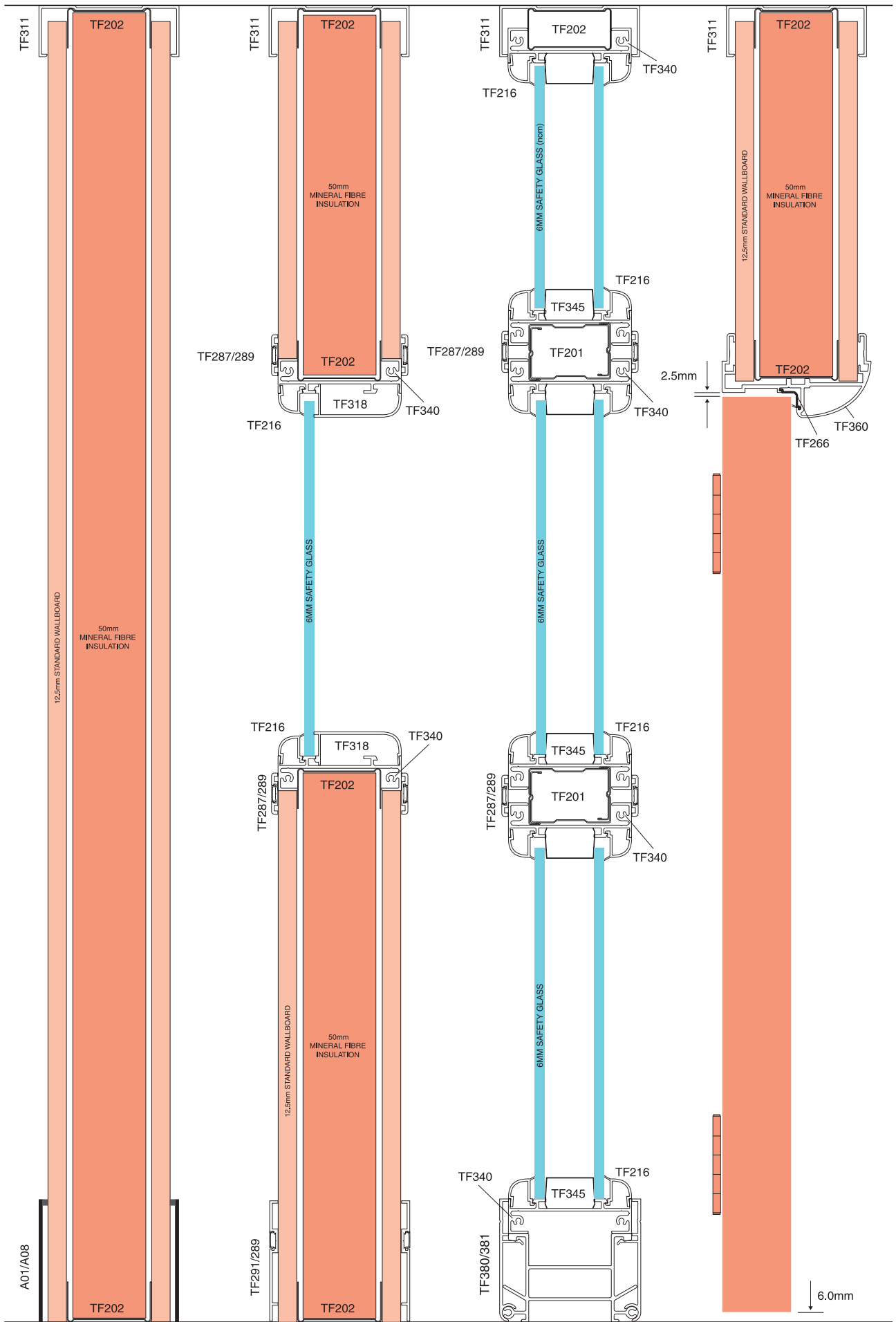

77mm Fire & Sound - Elevations

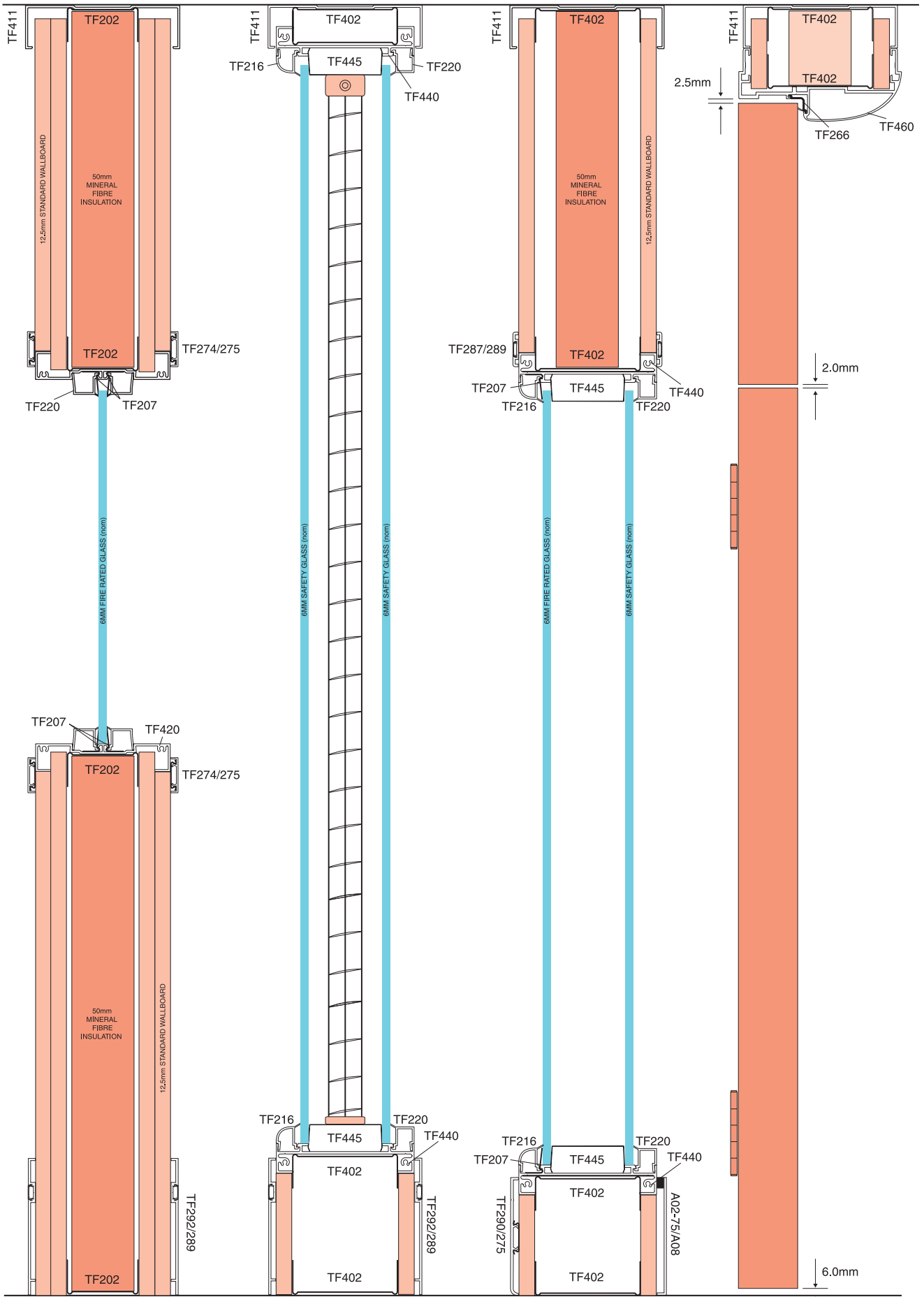

102mm Fire & Sound - Elevations

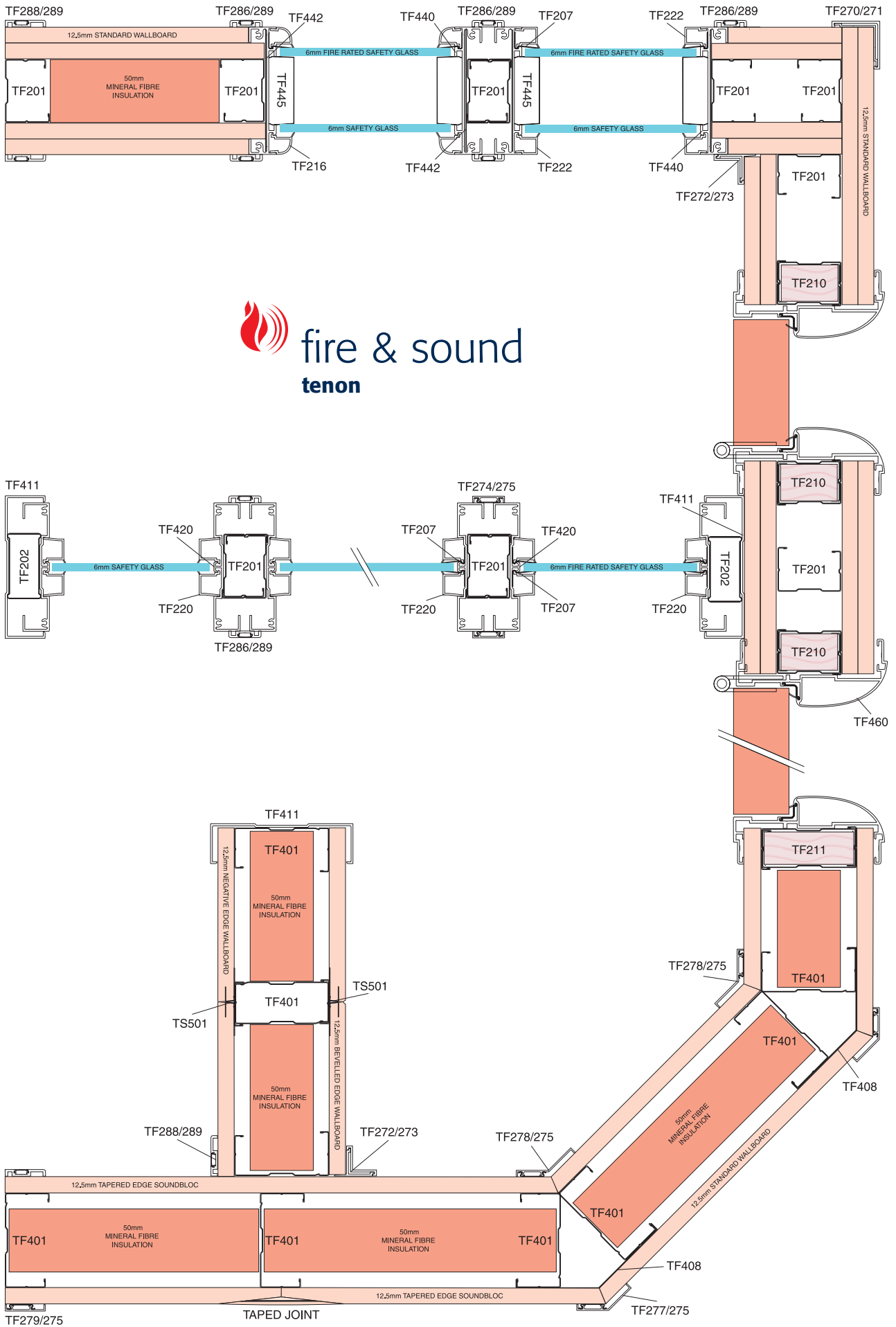

102mm Fire & Sound - Plan Details

Glazed Modules

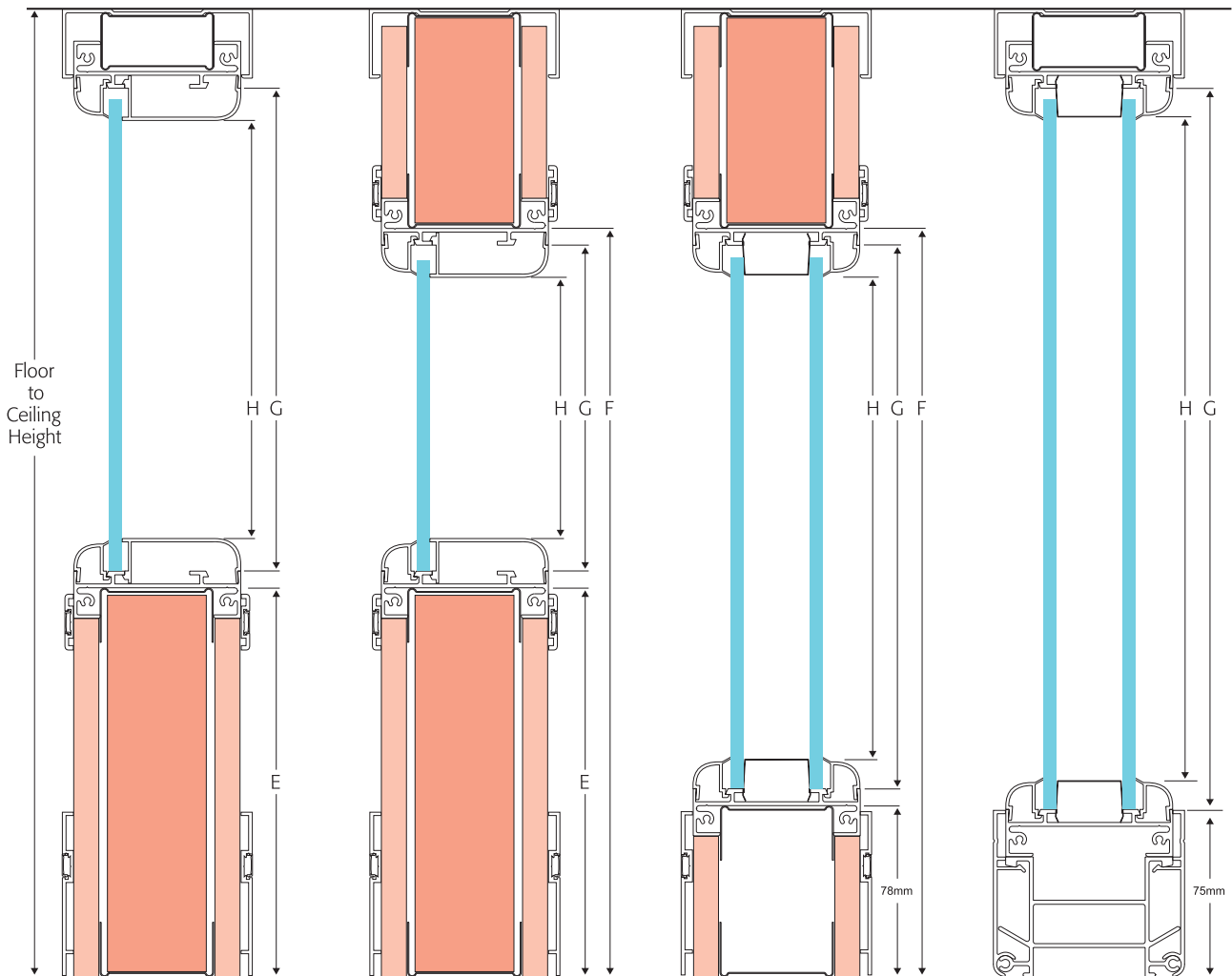
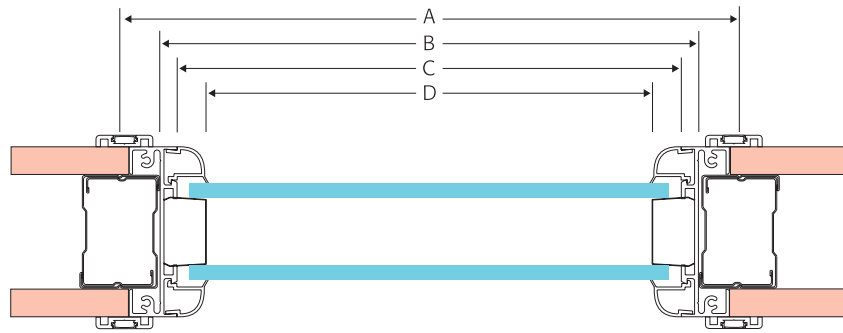

FIRE & SOUND	WIDTH		FIRE & SOUND	HEIGHT						
	DIMENSION	STANDARD MODULE		HALF GLAZED* (1200 x 1200)	HALF GLAZED** (1500 x 1200)	MID GLAZED (800 x 1200)	MID GLAZED (1000 x 1200)	GLAZED TO DOOR HEAD*** (1900 x 300 nom)	FULL HEIGHT WITH 75MM SKIRTING	FULL HEIGHT WITH BASE SECTION
	DIM A	1200mm	DIM E	1171mm	1171mm	1198mm	1198mm	N/A	N/A	N/A
	DIM B	Dim A - 35mm	DIM F	N/A	N/A	Door Height + 17mm	Door Height + 17mm	Door Height + 17mm	N/A	N/A
	DIM C	Dim A - 50mm	DIM G	1184mm	1484mm	784mm	984mm	1904mm	Floor to Ceiling Height - 123mm	Floor to Ceiling Height - 114mm
	DIM D	Dim A - 77mm	DIM H	1158mm	1458mm	758mm	958mm	1876mm	Floor to Ceiling Height - 149mm	Floor to Ceiling Height - 140mm

* Assumes a floor to ceiling height of 2400mm
 ** Assumes a floor to ceiling height of 2700mm
 *** Assumes the use of 75mm skirting

Fire & Sound - Glazing Setting Out Details

Door Modules

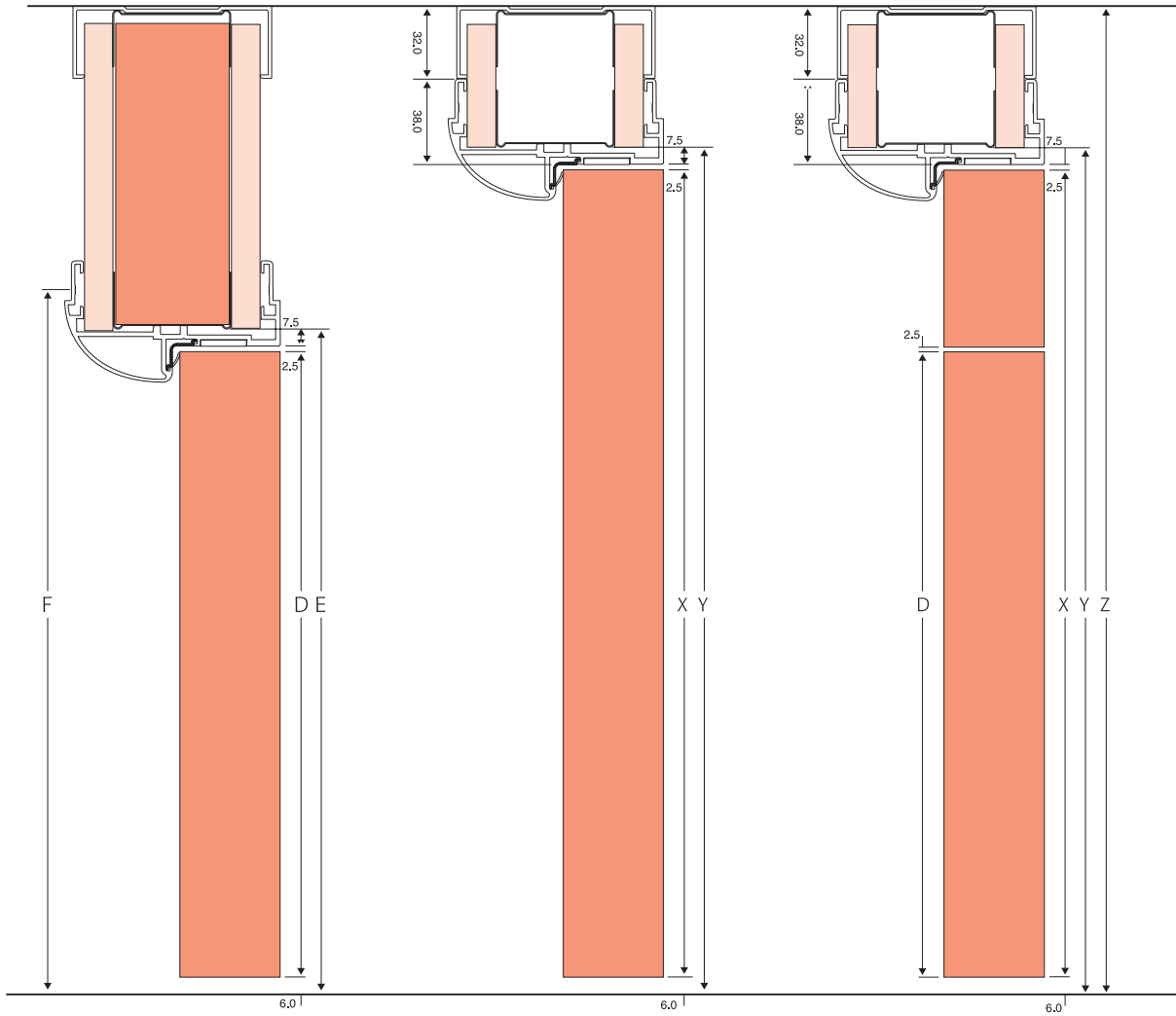
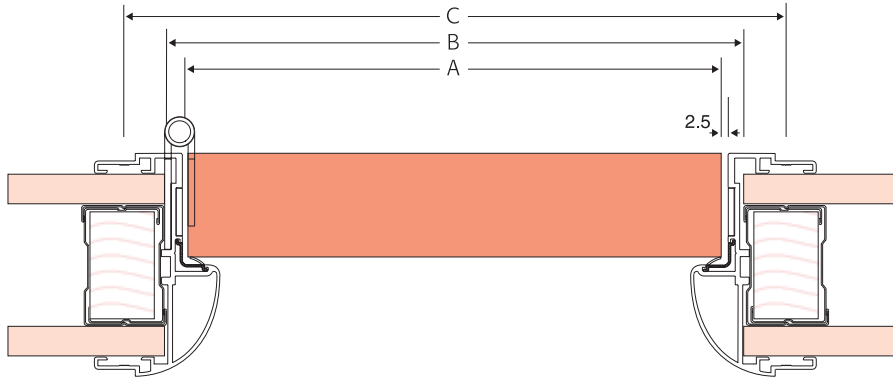

	WIDTH			
	SINGLE		DOUBLE	
	METRIC DOOR	IMPERIAL DOOR	METRIC DOOR	IMPERIAL DOOR
DIM A	826mm	838mm	1654mm	1678mm
DIM B	Dim A + 21mm	Dim A + 21mm	Dim A + 23mm	Dim A + 23mm
DIM C	Dim A + 56mm	Dim A + 56mm	Dim A + 58mm	Dim A + 58mm

	HEIGHT			
	SINGLE		FULL - O/P	
	METRIC DOOR	IMPERIAL DOOR	METRIC / IMPERIAL DOOR	
DIM D	2040mm	1981mm	DIM X	Dim Z - 78mm
DIM E	Dim D + 17mm	Dim D + 17mm	DIM Y	Dim Z - 62mm
DIM F	Dim D + 33mm	Dim D + 33mm	DIM Z	Floor to Ceiling Height

Fire & Sound - Door Frame Setting Out Details



fire & sound

tenon



TF201 50mm GALVANISED STEEL STUD
used for all vertical framework, singularly or boxed for solid construction, dependant on height and joint detail. Section is boxed for all glazing.



TF202 52mm GALVANISED STEEL CHANNEL
used at head, wall and floor details both singularly and boxed where appropriate with 50mm stud (TF201). Also used as notched transom with all glazing sections.



TF205 GALVANISED STEEL FIXING CHANNEL
used at all horizontal plasterboard joints.



TF207 STEEL GLAZING BEAD
use with all plastic glazing beads within aluminium glazing sections to achieve fire rated glazing.



TF210/211 SOFTWOOD STUD INSERT
use in conjunction with boxed steel stud section (TF201/1401) at either side of door frames to provide additional support for door frame leg and to give a suitable housing for fixings.



TF216 BLACK PLASTIC RADIUS DOUBLE/SINGLE GLAZING BEAD
use with double/single offset glazing section. Accepts glass with a thickness of between 6.0 and 7.0mm. Single offset with 75mm glazing section only.



TF220 BLACK PLASTIC SINGLE GLAZING BEAD
use with Single glazing section (TF340). Accepts glass with a thickness of between 6.0 and 7.0mm.



TF222 BLACK PLASTIC SQUARE DOUBLE/SINGLE GLAZING BEAD
use with double/single offset glazing section. glass with a thickness of between 6.0 and 7.0mm. Single offset with 75mm glazing - on only.



TF270/271 ALUMINIUM 90° EXTERNAL COVER TRIM & CLIP
used to cover 90° external corner joints. Clip section fitted at 600mm centres.



TF272/273 ALUMINIUM 90° INTERNAL CORNER TRIM & CLIP
used to cover 90° external corner joints. Clip section fitted at 600mm centres.



TF274 ALUMINIUM JOINT COVER TRIM
used to conceal board and glazing joints both vertically and horizontally. Used in conjunction with steel clamping strip (TF275).



TF275 STEEL CLAMPING STRIP
used to secure cover trims (TF274/277/278), offset cover trim (TF279) and skirting section (TF290).



TF277 ALUMINIUM 135° EXTERNAL CORNER TRIM
used to cover 135° external corner joints with steel clamping strip (TF275).



TF278 ALUMINIUM 135° INTERNAL CORNER TRIM
used to cover 135° external corner joints with steel clamping strip (TF275).



TF279 32mm ALUMINIUM OFFSET COVER TRIM
used as an alternative to head channel section and at solid wall abutments. Used in conjunction with steel clamping strip (TF275).



TF286 ALUMINIUM RADIUS VERTICAL COVER TRIM
used with plastic Omega insert (TF289). Trim pre-drilled at 600mm centres to accept a standard drywall screw.



TF287 ALUMINIUM RADIUS HORIZONTAL COVER TRIM
used with plastic Omega insert (TF289). Trim pre-drilled at 600mm centres to accept a standard drywall screw.



TF288 ALUMINIUM RADIUS ABUTMENT TRIM
used with plastic Omega insert (TF289). Trim pre-drilled at 600mm centres to accept a standard drywall screw.



TF289 PLASTIC OMEGA INSERT
use with sections (TF286/287/288/291/292/312/325) to conceal fixings.



TF290 75mm ALUMINIUM CONCEALED FIX SKIRTING
use at the base of the partition on both solid and glazed modules. Use with steel clamping strip (TF275).



TF291/292 75/100mm ALUMINIUM OMEGA CONCEALED FIX SKIRTING
used at the base of the partition on both solid and glazed modules. Fixings concealed with the use of TF298 plastic omega section.



TF293 STEEL TOP HAT TRIM SECTION
use with infill section (TF294/295). Suitable for non fire rated applications only.



TF294 STEEL TOP HAT TRIM INFILL
use with steel top hat section (TF293). Suitable for non-fire rated applications only



TF295 PLASTIC OMEGA INSERT
use with steel top hat section (TF293). Suitable for non-fire rated applications only.



TF308 135° INTERNAL STEEL PLATE
used to form 135° corners.



TF311 77mm ALUMINIUM HEAD CHANNEL
used for all applications except under combustible ceilings. Also used as an abutment section for both solid and glazing.



TF312 77mm ALUMINIUM END CAPPING SECTION
used at the free ends of partition runs. Use with omega insert strip (TF289) to conceal fixings.



TF313 77mm ALUMINIUM Y POST SECTION
used to create Y junctions in conjunction with stud section (TF201) and trim sections (TF274/275).



TF315 77mm ALUMINIUM THREE WAY CONVERSION POST
used to convert Tenon Fire & Sound dividing walls to Tenon Flexplus along the front of offices.



TF318 ALUMINIUM SINGLE OFFSET GLAZING SECTION
used to create single offset glazing in conjunction with 77mm aluminium glazing section (TF340) and plastic glazing beads (TF216/222). 77mm system only is always mitred and therefore requires fitting as the glazing frame is assembled. Non-fire rated.



TF320 77mm ALUMINIUM SINGLE CENTRE GLAZING SECTION
used for both non-fire rated and fire rated single. Used in conjunction with plastic glazing bead (TF320) together with steel glazing bead (TF207) in fire rated applications. Also, supplied in pre-notched form for as a transom (TF320/12).



TF323 77mm ALUMINIUM THREE WAY POST
used to create three way junctions, accepting any combination of glazing, solid or door modules. Use timber packer (TF212) when fitting door frame directly to the post. No additional trims are required.



TF325/ TV836 77mm ALUMINIUM CABLE MANAGEMENT POST
used to house electrical and venetian blind cabling. Post suitable for use with Crabtree architrave switch and back box ref: 4077/4177. Use with plastic omega (TF289) and timber packer (TF213) when fitting next to door frames.



TF326 77mm ALUMINIUM RADIUS 90° CORNER POST
used for 90° corner junctions, accepting a combination of glazing, solid or door modules. Use timber packer (TF212) when fitting door frame directly to the post. No additional trims are necessary.



TF327 77mm ALUMINIUM RADIUS 135° CORNER POST
used for 135° corner junctions, accepting a combination of glazing, solid or door modules. Use timber packer (TF212) when fitting door frame directly to the post. No additional trims are necessary



TF340/345 77mm DOUBLE GLAZING SECTION AND SPACER
used for non-fire and fire rated double glazing. Use plastic glazing beads (TF216/TF222) and steel liner (TF342) steel glazing bead (TF207) in fire rated applications. Single offset glazing is created by the use of glazing section (TF318).



TF342 STEEL DOUBLE GLAZING LINER
use with double glazing section (TF340) in fire rated applications.



TF360 77mm ALUMINIUM UNIVERSAL DOOR FRAME
milled for and including one pair of 100mm steel hinges, Tenon lockbox, door seal (TF266) and mitre cleats (TF262). Door frame pre-cut and mitred at ends to allow frame to be used for both right hand left hand doors.



TF380/381 77mm ALUMINIUM BASE AND CLIP FIT SKIRTING SECTION
used as a main base channel in place of steel (TF202). Skirting section (TF381) clip fits onto main section (TF380) to provide easy access for cable management clip if required.

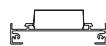

TF440/445 102mm DOUBLE GLAZING SECTION AND SPACER
used for non-fire and fire rated double glazing. Use with plastic glazing beads (TF216/TF222) and steel liner (TF442) / steel glazing bead (TF207) in fire rated applications. Single offset glazing not available with this section.



TF401 75mm GALVANISED STEEL STUD
used for all vertical framework, singularly or boxed solid construction, dependant on height and joint detail. Section is boxed for all glazing.



TF460 102mm ALUMINIUM UNIVERSAL DOOR FRAME
milled for and including one pair of 100mm steel hinges, Tenon lockbox, door seal (TF266) and mitre cleats (TF262). Door frame pre-cut and mitred at ends to allow frame to be used for both right hand and left hand doors.



TF402 77mm GALVANISED STEEL CHANNEL
used at head, wall and floor details both singularly and boxed where appropriate with 50mm stud (TF401). Also used, as notched transom with all glazing sections.

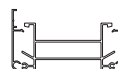

TF480/381 102mm ALUMINIUM BASE AND CLIP FIT SKIRTING SECTION
used as a main base channel in place of steel (TF202/402). Skirting section (TF381) clip fits onto section (TF480) to provide easy access for cable management if required.



TF411 102mm ALUMINIUM HEAD CHANNEL
used for all applications except under combustible ceilings. Also used as an abutment section for both solid and glazing.



A01 LAMINATE SKIRTING
face fixed skirting 75/100/150mm high. Use with 8 x 6mm black skirting foam (A08).



TF420 102mm ALUMINIUM SINGLE CENTRE GLAZING SECTION
used for both non-fire rated and fire rated single glazing. Used in conjunction with plastic glazing (TF220) together with steel glazing bead (TF207) in rated applications. Also supplied in pre-notched for use as a transom (TF420/12).



A02 ALUMINIUM SKIRTING
face fixed skirting 75/100mm high. Use with 8 x 6mm black skirting foam (A08).



TF442 STEEL DOUBLE GLAZING LINER
use with double glazing section (TF440) in fire rated applications.



TS501 BOARD EDGE CLIP
used for the fitting of negative and bevelled edge plasterboards to stud sections (TF201/TF401).

Performance Summary

	SYSTEM	77mm Fire & Sound	102mm Fire & Sound	102mm Fire & Sound
FIRE	CONSTRUCTION	One layer of 12.5mm plasterboard fitted either side of Tenon 50mm stud with 50mm mineral fibre slab in cavity	One layer of 12.5mm plasterboard fitted either side of Tenon 75mm stud with 50mm mineral fibre slab in cavity	Two layers of 12.5mm plasterboard fitted either side of Tenon 50mm stud with 50mm mineral fibre slab in cavity
30 Minutes Integrity 30 Minutes Insulation	SOLID - TF274 Cover Trim	✓	✓	✓
	SOLID - TF286 Cover Trim	✓	✓	✓
	SOLID - Bevelled Joint	✓	✓	
	SOLID - Pencil-Line Joint	✓	✓	
60 Minutes Integrity 60 Minutes Insulation	SOLID - Taped Joint	✓	✓	✓
	SOLID - TF274 Cover Trim			✓
	SOLID - TF286 Cover Trim			✓
30 Minutes Integrity*	SOLID - Taped Joint			✓
	GLAZED - Single Glazing	✓	✓	✓
30 Minutes Integrity*/ Insulation**	GLAZED - Double Glazing	✓	✓	✓
	GLAZED - Double Glazing	✓	✓	✓
60 Minutes Integrity***	GLAZED - Single Glazing			✓
	GLAZED - Double Glazing			✓
30 Minutes Integrity	DOOR - Single Door	✓	✓	✓
	DOOR - Double Door	✓	✓	✓
	DOOR - Hospital Door	✓	✓	✓
	DOOR - Full Height Door	✓	✓	✓
	DOOR - Full Height Door	✓	✓	✓
60 Minutes Integrity****	DOOR - Single Door			✓
	DOOR - Double Door			✓









* Pyroshield safety glass, Pyran, Pyrocet and Pyroguard only. ** Pyrobel glass only. Excludes insulation to mullions *** Pyran and Pyrocet only **** Timber doors only

ACOUSTIC / STRUCTURAL	Stud Size	Single / Boxed	Plasterboard / Glass Type	Plasterboard / Glass Thickness	Single/Double	Insulation Type	dB Rating	Maximum Construction Height
77mm - Solid	50mm	Single	Standard	12.5mm	Single Skin	None	34dB _(RW)	3000mm
	50mm	Single	SoundBloc	12.5mm	Single Skin	None	37dB _(RW)	3000mm
	50mm	Boxed	Standard	12.5mm	Single Skin	50mm 45kg/m ³	40dB _(RW)	3600mm
	50mm	Boxed	SoundBloc	12.5mm	Single Skin	50mm 45kg/m ³	44dB _(RW)	3600mm
102mm - Solid	50mm	Single	Standard	12.5mm	Double Skin	None	42dB _(RW)	3600mm
	50mm	Single	SoundBloc	12.5mm	Double Skin	None	46dB _(RW)	3600mm
	50mm	Boxed	Standard	12.5mm	Double Skin	50mm 45kg/m ³	49dB _(RW)	4200mm
	50mm	Boxed	SoundBloc	12.5mm	Double Skin	50mm 45kg/m ³	52dB _(RW)	4200mm
77mm - Glazed	50mm	Boxed	Laminated	6.4mm	Single Glazed	N/A	33dB _(RW)	3000mm*
	50mm	Boxed	Acoustic Lam	6.8mm	Single Glazed	N/A	35dB _(RW)	3000mm*
	50mm	Boxed	Laminated	6.4mm	Double Glazed	N/A	35dB _(RW)	3000mm*
	50mm	Boxed	Acoustic Lam	6.8mm	Double Glazed	N/A	40dB _(RW)	3000mm*
102mm - Glazed	50mm	Boxed	Laminated	6.4mm	Double Glazed	N/A	35dB _(RW)	3000mm*
	50mm	Boxed	Acoustic Lam	6.8mm	Double Glazed	N/A	40dB _(RW)	3000mm*
Door Module							30dB _(RW)	

*Please consult the Tenon Technical Department for advice on glazed partitions above 3000mm.



Fire & Sound is only one of the systems that forms the Tenon range. Other products in the range include:

- | | |
|--|--|
|  flexplus |  washrooms |
|  ovation |  operable walls |
|  scion |  vitrage |
|  wall store |  accessories |

www.tenonpartitions.co.uk

For further information on Fire & Sound or any other products in the Tenon range, please contact:



A product of CPD Distribution plc
Hillsborough Works, Langsett Road, Sheffield S6 2LW
Tel: 0114 231 8030 Fax: 0114 231 8031



© Copyright and Design right. CPD Distribution plc 2004
Fire & Sound is a Registered Trademark of CPD Distribution plc.

